

- **Specification**

- .250" PCB Barrier Terminal Blocks
- Pitch : 6.35 mm

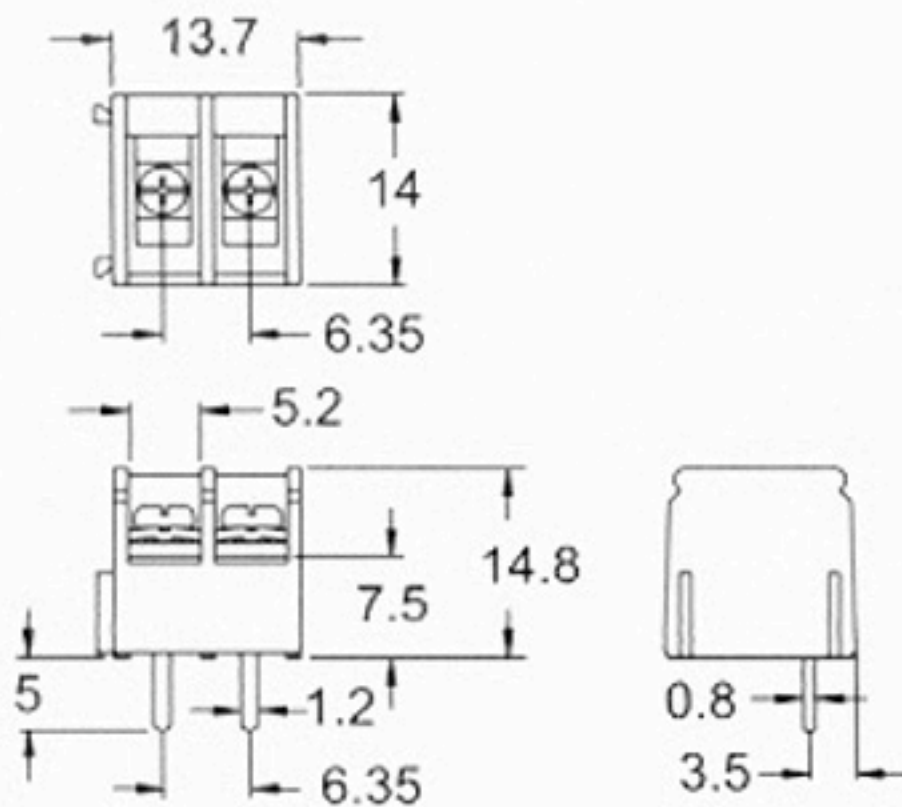
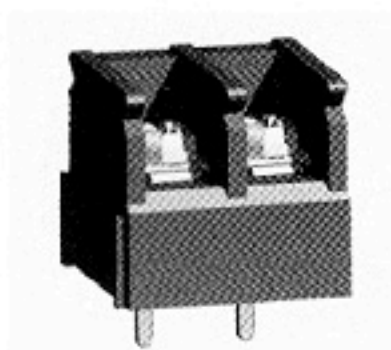

T40MBS11-02		2 pole modular
T40MBS11-03		3 pole modular
T40MRS11-02		2 pole modular w/o wall (right side)
T40MRS11-03		3 pole modular w/o wall (right side)
T30M-R01		mounting hole
BC40M-□□		clear cover