

- **Specification**

- .374" PCB Barrier Terminal Blocks
- Terminal style : B32
- Pitch : 9.50 mm

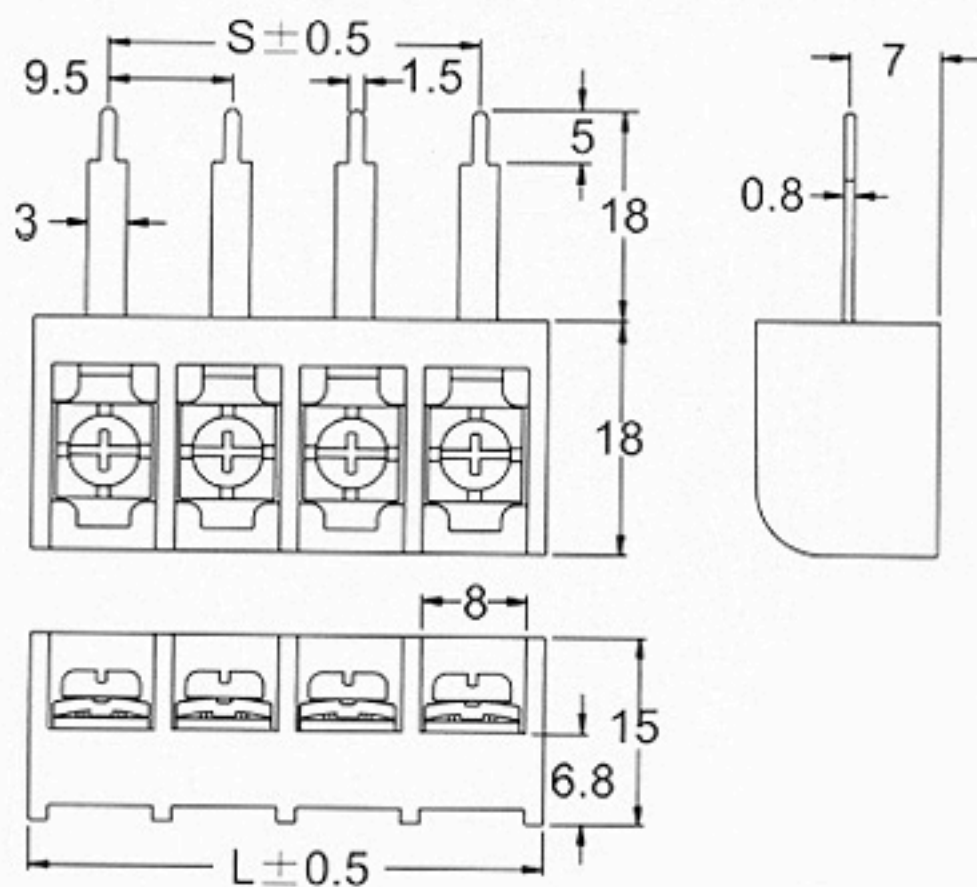
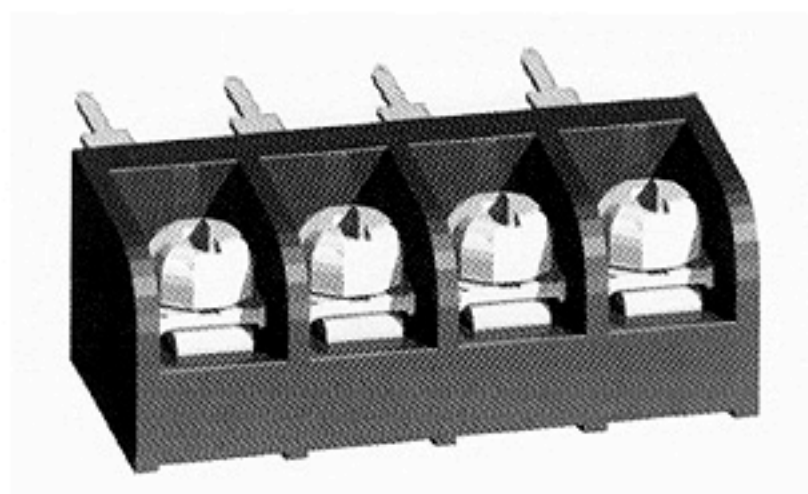

Poles	2	3	4	5	6	7	8	9	10	11	12	13	14	15	16
L(mm)	20.4	29.9	39.4	48.9	58.4	67.9	77.4	86.9	96.4	106	115	125	134	144	153
S(mm)	9.50	19.0	28.5	38.0	47.5	57.0	66.5	76.0	85.5	95.0	105	114	124	133	143
Poles	17	18	19	20	21	22	23	24	25	26					
L(mm)	163	172	182	191	201	210	220	229	239	248					
S(mm)	152	162	171	181	190	200	209	219	228	238					