

- **Specification**

- .433" PCB Barrier Terminal Blocks
- Terminal style : S11
- Pitch : 11.00 mm

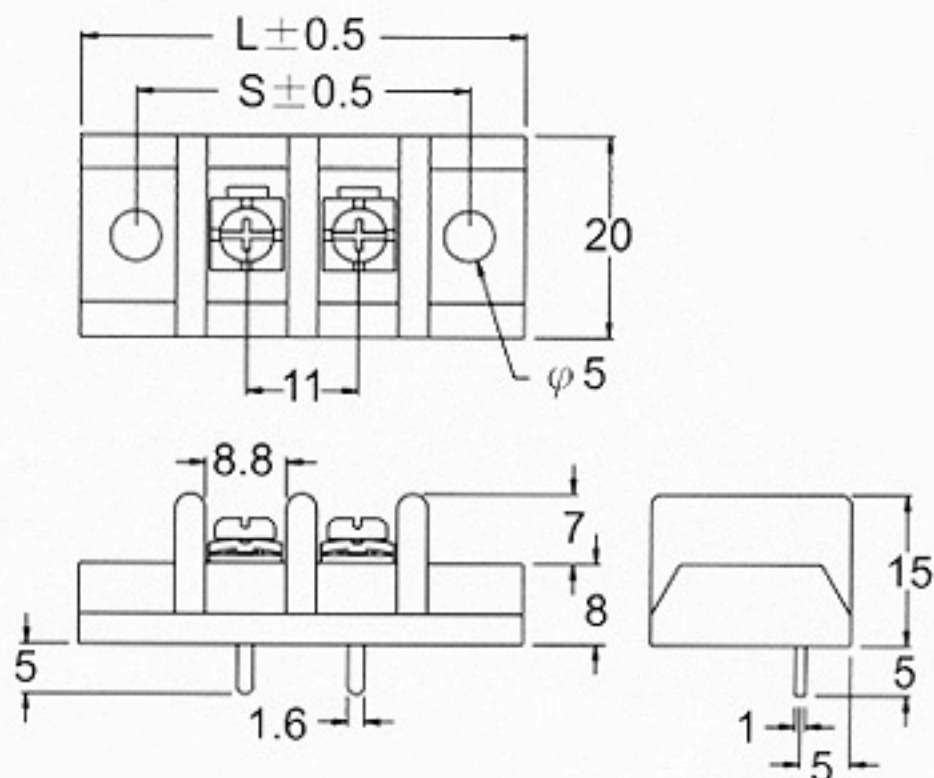
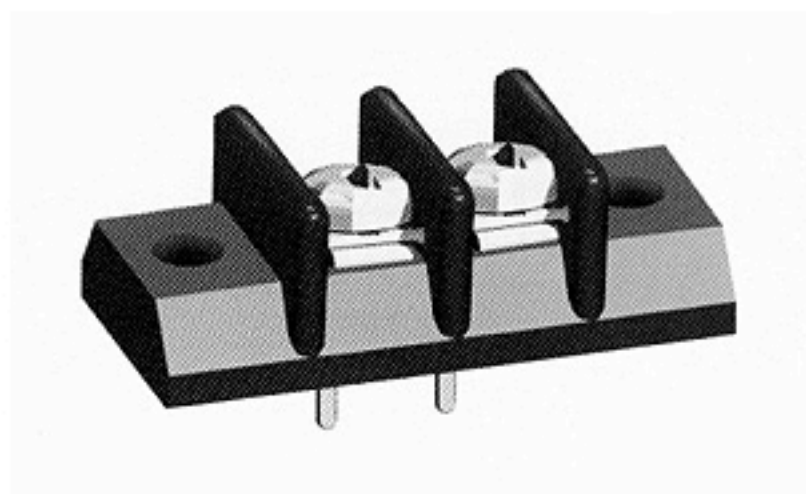

Poles	2	3	4	5	6	7	8	9	10	11	12	13	14	15	16
L(mm)	46.1	57.1	68.1	79.1	90.1	101	112	123	134	145	156	167	178	189	200
S(mm)	33.0	44.0	55.0	66.0	77.0	88.0	99.0	110	121	132	143	154	165	176	187
Poles	17	18	19	20	21	22	23	24							
L(mm)	211	222	233	244	255	266	277	288							
S(mm)	198	209	220	231	242	253	264	275							