

- **Specification**

- .433" PCB Barrier Terminal Blocks
- Terminal style : 25
- Pitch : 11.00 mm

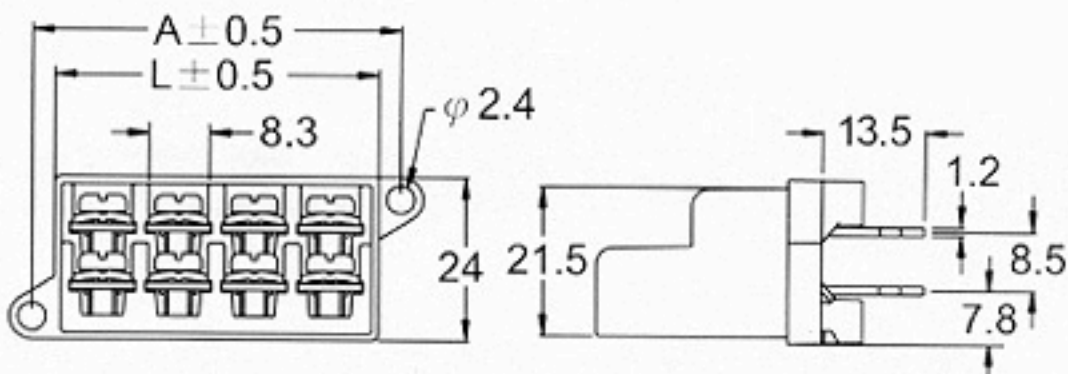
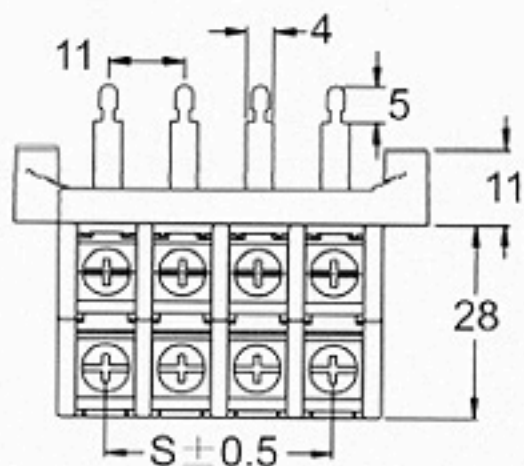

Poles	2	3	4	5	6	7	8	9	10	11	12				
A(mm)	31.5	42.5	53.5	64.5	75.5	86.5	97.5	109	120	131	142				
L(mm)	25.2	36.2	47.2	58.2	69.2	80.2	91.2	103	114	125	136				
S(mm)	11.0	22.0	33.0	44.0	55.0	66.0	77.0	88.0	99.0	110	121				